

Wireless Drop Counter PS-3214

Power: Rechargeable Battery
Connection:  Bluetooth[®] or USB Cable
SMART

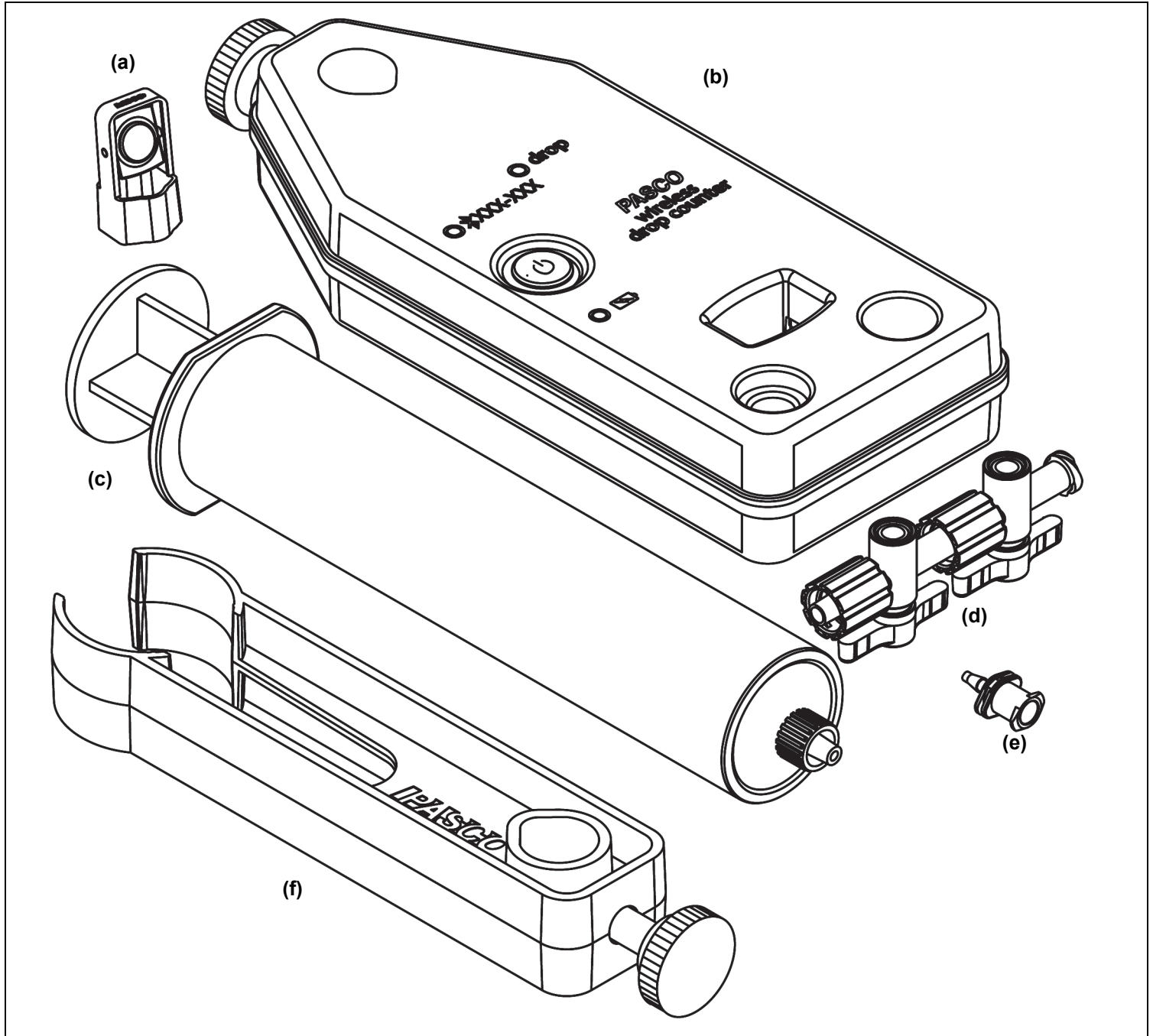

Equipment Included	
(a) Micro Stir Bar	(d) Stopcock Valves (2)
(b) Wireless Drop Counter	(e) Drop Tip
(c) Syringe (60 mL)	(f) Syringe Holder
Micro USB Cable (1 meter) - NOT SHOWN	

Required Item*	Part Number*
PASCO Data Collection Software	see www.pasco.com

*See the PASCO catalog or the PASCO web site www.pasco.com for more information.

Recommended Items*	Recommended Items*
pH Sensor	Temperature Sensor
Support Rod and Table Clamp	Magnetic Stir Plate
Beaker, 150 mL	Graduated Cylinder, 10 mL

Consumables	Consumables
0.1 M NaOH	0.005 M HCl

Introduction

The PASCO Wireless Drop Counter is a versatile measuring device that can connect to a computer or mobile device wirelessly through Bluetooth (BLE) or physically through a USB port. It includes a rechargeable battery and a Micro USB Cable. It measures the number of drops of fluid that fall through the rectangular opening (drop window) of the sensor and converts the drops into a volume. It is typically used in conjunction with a pH sensor and other equipment to perform a titration. Data from the Wireless Drop Counter and other sensors are recorded and displayed using software such as SPARKvue or PASCO Capstone. SPARKvue allows the sensor to work with a computer or a mobile device such as a tablet or smart-phone when the sensor is connected. PASCO Capstone will work on a PC or Mac.

The Wireless Drop Counter can be mounted on a support rod. The counter is equipped with two integrated probe holders. The included Micro Stir Bar fits onto the end of a pH probe or probe of the same diameter.

The included syringe, syringe holder, stopcock valves, and drop tip can be assembled into a drop dispenser that can also be mounted on a support rod.

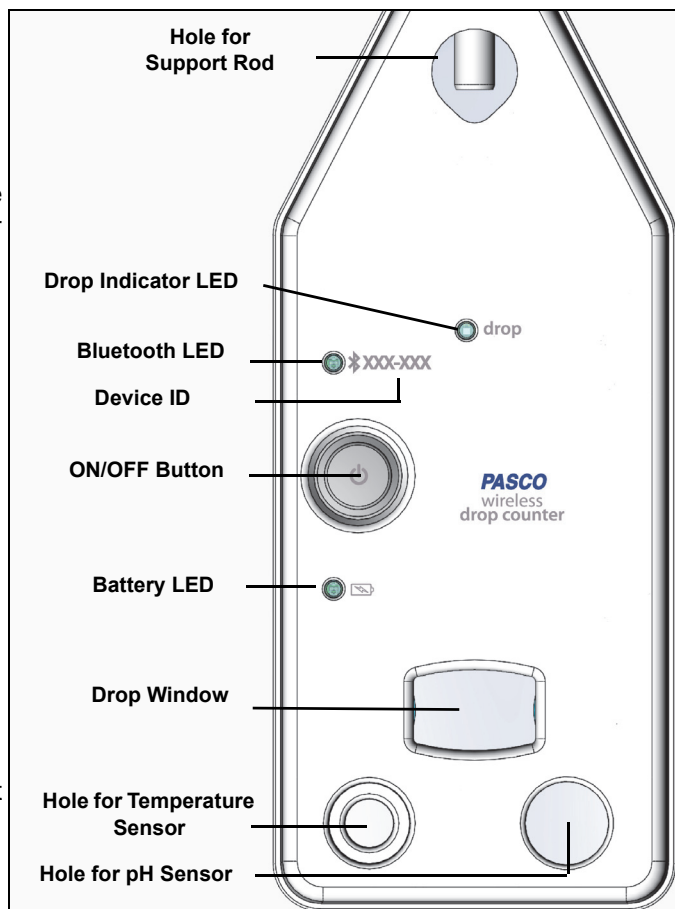

Initial Step: Charge the Battery

- Connect the Cable:** On the back of the Wireless Drop Counter, pry open the rubber seal that covers the Micro USB port. Use the included Micro USB Cable to connect the micro USB port on the back of the sensor to a USB port or USB charger such as the PASCO PS-2575 USB Single Port Charger. Charging begins automatically. The charger circuit inside the sensor turns itself off when the unit is fully charged. The battery status LED will shine yellow as the battery is charging, and will shine green when the battery is charged. The battery is partially charged at the factory. Initial charging time may be three hours or longer depending on the power source and the condition of the battery.

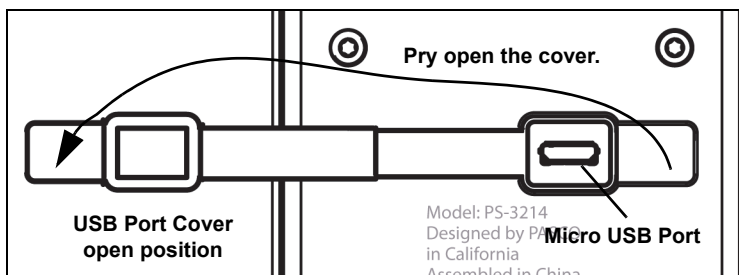

Using the Sensor

The sensor is designed to work with PASCO data collection software to measure the number of drops that fall through the drop window.

ON/OFF and Sleep Information

Before turning the sensor on, make sure that nothing is blocking the drop window. To turn the sensor on, press and **hold** the ON button. When the battery status LED shines red for a moment, release the ON button. Then, the Bluetooth status LED will blink. This indicates that the sensor is ready to be “paired” with a device using the data collection software. NOTE: The sensor calibrates itself each time that it is turned on and therefore it is important that the drop window is unblocked when the sensor is turned on.

To turn the sensor off, press and **hold** the ON button for a moment until the battery status LED shines red. Release the ON button and the Bluetooth status LED stops blinking. The sensor puts itself to sleep after one hour of inactivity if connected, and after several minutes if not connected.

Data Collection Software

PASCO Capstone



- Mac OS X
- Windows

SPARKvue



- Mac OS X
- Windows
- iOS
- Android
- Chromebook

See the PASCO web site at www.pasco.com/software for help in selecting the right PASCO software and to check for the latest versions.

Software Help

- In Sparkvue, open the Main Menu and select “Help” for information about collecting, displaying, and analyzing data.

- In the window that opens is the address of the web page for **Help**. Copy and paste the address into a web browser program to open the Sparkvue User’s Guide web page.
- SPARKvue User’s Guide web page”

Help

See the following webpage for more information:
<http://cdn.pasco.com/help/sparkvue/enu>

SPARKvue “Help” Window

SPARKvue User’s Guide
Version: 2.5

Q



Featuring new wireless lab activities: See the "NEW" SPARKlabs in [Experiments](#).

For information on the new PASCO wireless devices, see: www.pasco.com/wireless.

- In PASCO Capstone, select **PASCO Capstone Help** from the **Help** menu, or press **F1**.

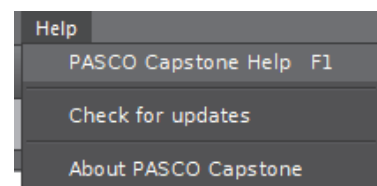

LED Information

The “drop” LED operates as follows:

The “drop” LED blinks when a drop is detected passing through the drop window.

If the lens in the drop window becomes obscured or dirty, the “drop” LED shines continuously. Clean the lens with water or a glass cleaner and a piece of lens paper or a lint-free cloth. Dry with a cotton swab.

The Bluetooth and the Battery Status LEDs operate as follows:

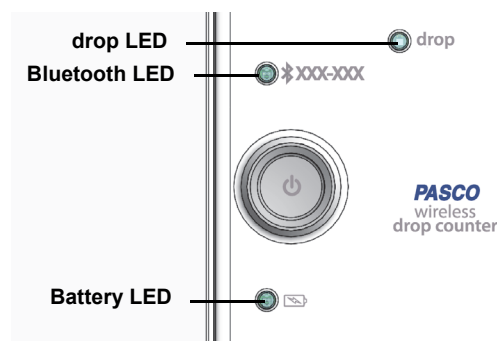

For a wireless Bluetooth connection:

Bluetooth LED	Status
Red blink	Ready to pair
Green blink	Connected

Battery LED	Status
Red blink	Low power

For a micro USB cable connection to a USB port:

Bluetooth LED	Status
OFF	-none
OFF	-none

Battery LED	Status
Yellow ON	Charging
Green ON	Charged

For a micro USB cable connection to a USB charger:

Bluetooth LED	Status
Red blink	Ready to pair
Green blink	Connected

Battery LED	Status
Yellow ON	Charging
Green ON	Charged

Assembling the Titration Setup (See figure on next page)

1. Put the Wireless Drop Counter on a support rod.
2. Attach a pH Probe to a Wireless pH Sensor. Put the pH probe into the larger of the two sensor ports on the Wireless Drop Counter.
3. Mount the Micro Stir Bar to the end of the pH Probe.
4. Arrange the magnetic stirrer and a 150 mL beaker with 100 mL of 0.005 M HCl so that the end of the pH Probe and the Micro Stir Bar are in the liquid in the beaker.

Assemble the Drop Dispenser

1. Remove the plunger from the syringe. Remove the protective white plastic caps from the stopcock valves.
2. Connect the two stopcocks together. Connect the stopcocks to the end of the syringe.
3. Connect the drop tip to the bottom of the stopcocks.
4. Attach the Drop Dispenser (syringe, two stopcocks, and drop tip) to the support rod above the Wireless Drop Counter.
5. Align the Drop Dispenser so that the drop tip is over the rectangular window of the Drop Counter.

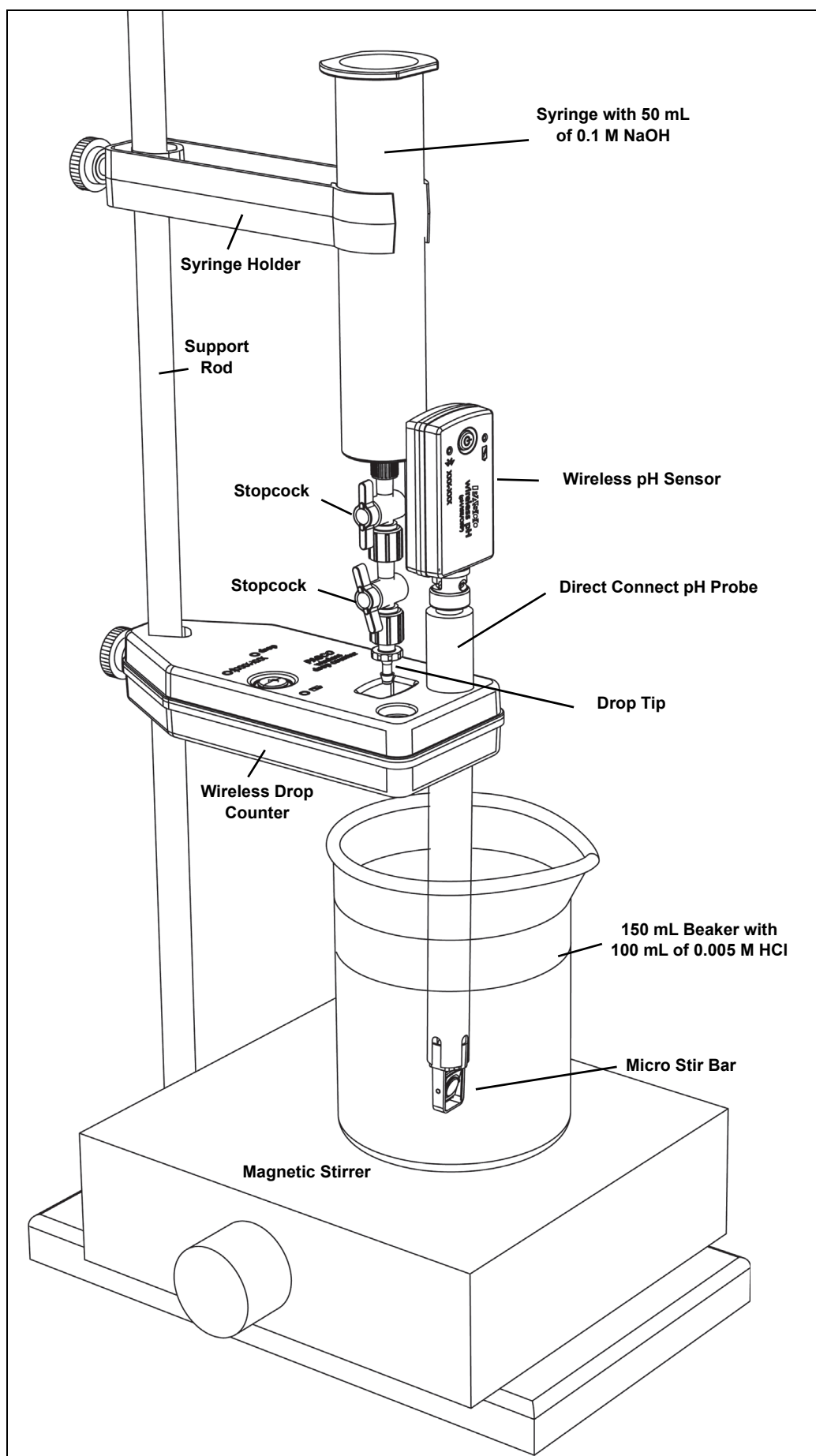

Calibrating the Drop Counter

The Drop Dispenser has two stopcocks. The bottom stopcock is used to regulate flow rate and the top stopcock is used to turn the flow on and off. The top stopcock should either be in the completely open (handle vertical) or completely closed (handle horizontal) position.

The following two methods illustrate the calibration procedure.

Calibration (Generic Process using PASCO Capstone)

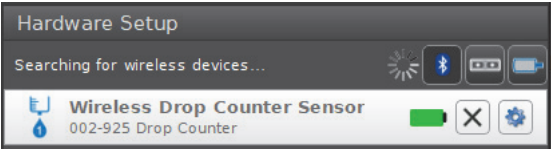
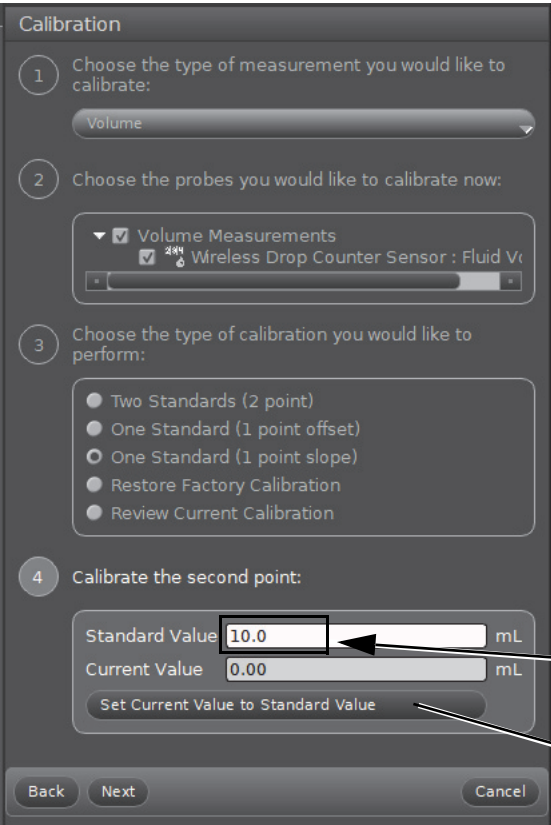
1. Attach the Drop Dispenser (syringe, two stopcocks and drop tip) to a support rod.
2. Fill the syringe with titrant. Put a beaker under the Drop Dispenser to catch the titrant.
3. Open both stopcock valves and adjust the valve on the bottom stopcock so that the drops fall at a rate of about 1 drop per second. Close the top valve after the rate is achieved. Discard the titrant in the beaker as directed by the instructor.
4. Align the drop tip with the rectangular window in the Wireless Drop Counter. Put a graduated 10 mL cylinder under the Drop Counter window so it can catch drops from the drop tip and give you a measure of the volume.
5. Start Capstone. "Pair" the Wireless Drop Counter wirelessly to the computing device (e.g., computer). In Capstone, open the "Hardware Setup" window and click the Drop Counter with the Device ID that matches the number on your sensor.
 
6. In Capstone, click the "Calibration" icon in the "Tools" panel to open the Calibration window. In Step 1, select the Volume measurement and click "Next". In Step 2 the "Wireless Drop Counter Sensor" is picked by default. In Step 3, the default choice for type of calibration is "One Standard (1 point slope)", Click "Next" to open Step 4.
 
7. Open the top stopcock valve to let the titrant begin dripping into the cylinder. NOTE: Capstone will automatically record the number of drops. (You do not need to click "Record".)
8. After about 5 mL of titrant is collected in the graduated cylinder, close the top stopcock. Carefully measure the exact volume of titrant in the graduated cylinder.
9. In Capstone, highlight the number in the "Standard Value" text box in Step 4. Enter the exact volume of titrant that you collected in the graduated cylinder (5 mL in this example). Next, click the button "Set Current Value to Standard Value".

Highlight the number and then enter the exact volume here.

Next, click here.

10. Step 5 opens automatically and it shows the “New Calibration” in the lower part. NOTE: In this example, Capstone counted 10 drops. Since the volume was 5.0 mL, the “New Calibration” shows “Slope” equal to “0.500 mL/drops”.
11. In Capstone, click “Finish” to return to Step 1. Click the “Calibration” icon in the Tools panel to close the Calibration window.

Calibration (Generic Process using SPARKvue on a Computer or Tablet)

1. Attach the Drop Dispenser (syringe, two stopcocks and drop tip) to a support rod.
2. Fill the syringe with titrant. Put a beaker under the Drop Dispenser to catch the titrant.
3. Open both stopcock valves and adjust the valve on the bottom stopcock so that the drops fall at a rate of about 1 drop per second. Close the top valve after the rate is achieved. Discard the titrant as directed by your instructor.
4. Align the drop tip with the rectangular window in the Wireless Drop Counter. Put a graduated 10 mL cylinder under the Drop Counter window so it can catch drops from the drop tip and give you a measure of the volume.
5. Start SPARKvue.

- The “choose a path” window opens.

6. To “pair” the Wireless Drop Counter wirelessly to the computing device (e.g., computer or tablet), click or touch “Sensor Data” in the “choose a path” window.

- The “Sensor Data Configuration” window opens.

7. In the “Sensor Data Configuration” window, look in the “Connected Devices” list. Touch or click to select the correct address that matches the Device ID XXX-XXX number found on the Wireless Drop Counter.

- A message confirms that the sensor is being connected.

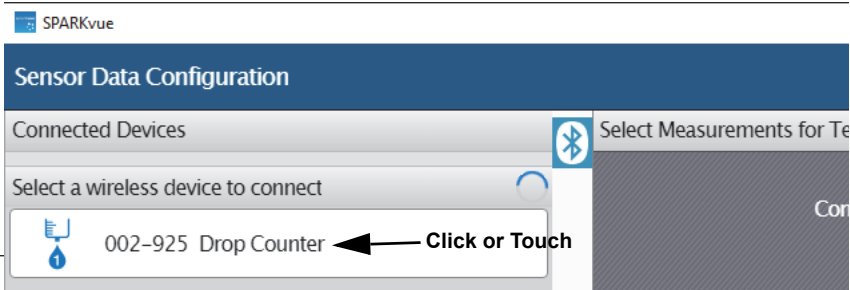
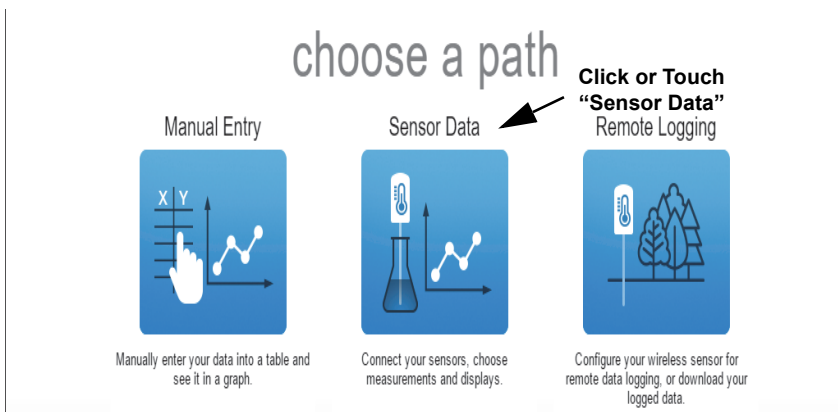
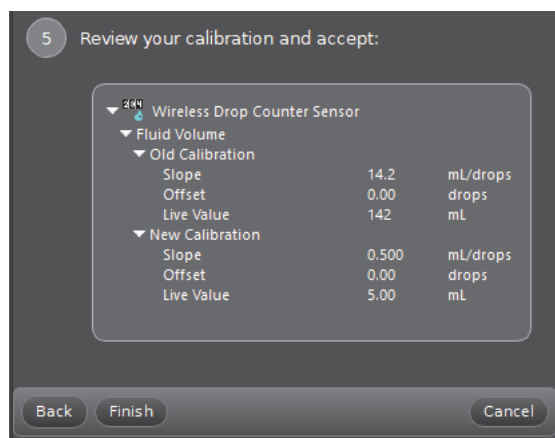

- Next, in the “Sensor Data Configuration” window, the “Select Measurement for Templates” menu opens and “Fluid Volume” is the measurement selected as default. The “Templates” window also opens with “Graph”, “Table and Graph”, and “Digits” as the choices.

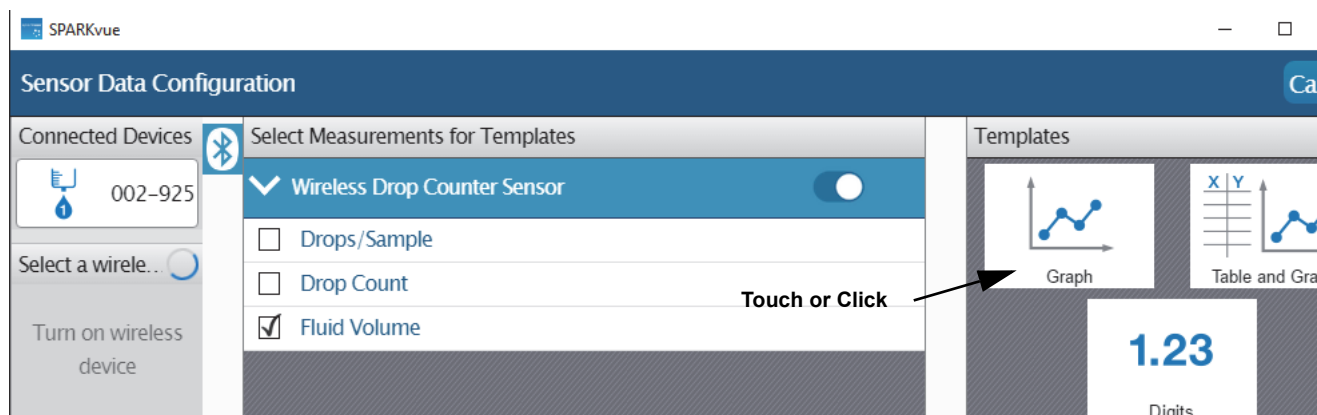

- In the “Templates” window, touch or click the “Graph” template to open a “Graph” display.



- The Graph display shows “Fluid Volume (mL)” as the measurement on the vertical axis. The “Hardware Setup” icon is in the lower right-hand corner.

9. Touch or click the “Hardware Setup” icon to open the “Configure Sensors and Measurements” menu.
 - The menu shows the sensor name and the three measurement choices. Note that each measurement has a gear-shaped “Edit Data Properties” icon. Note that the “Fluid Volume” measurement also has a “Calibrate measurement” icon.
10. Click or touch the “Calibrate measurement” icon to open the “Calibrate Sensor: Select Measurement” window.

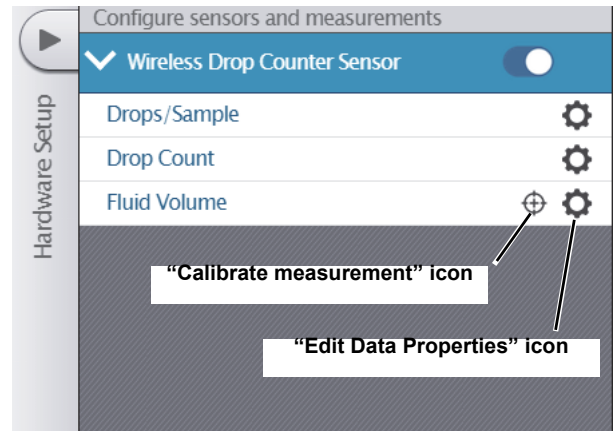

Calibrate Sensor: Select Measurement ?

Start New Calibration

1. Select a sensor:

Wireless Drop Counter Sensor

2. Select a measurement:

Fluid Volume (mL)

3. Select a Calibration Type:

1 point (Adjust Slope Only)

Continue

Restore Factory Calibration

Done

11. In the “Calibrate Sensor: Select Measurement” window, touch or click “Continue” to open the “Calibrate Sensor: Enter Values” window
 - The “Calibrate Sensor Enter Value” window opens. Note that the window has a text area for “Standard Value: 10.0000..... ml” and a display area for “Sensor Value: 0.0000..... drops”

12. Make sure that the Drop Dispenser and Wireless Drop Counter are ready. Open the top stopcock valve to let the titrant begin dripping into the cylinder. NOTE: SPARKvue will automatically record the number of drops. (Watch the “Sensor Value:” display area to monitor the number of drops as they are counted.)

13. After about 5 mL of titrant has collected in the graduated cylinder, close the bottom stopcock. Carefully measure the exact volume of titrant in the graduated cylinder.

14. Next, highlight the number in the “Standard Value” text box and then enter the exact volume of titrant that you collected in the graduated cylinder (5.0 mL in this example). Next, touch or click the button “Set Calibration”

Calibrate Sensor: Enter Values

▶ Calibration Point 1

▼ Calibration Point 2

Standard Value: 10.0000 mL

Sensor Value: 10.000 ← Watch the number of drops here drops

Set Calibration

▶ New Calibration

Cancel OK

Calibrate Sensor: Enter Values

▶ Calibration Point 1

▼ Calibration Point 2

Standard Value: 10.0000 mL

Sensor Value: 10.000 drops

Set Calibration

Highlight the number and then enter the exact volume of titrant you collected

15. Touch or click “New Calibration” to see the Slope and Offset values. In this example, the Slope is “2.0000 drops/mL” because 10 drops were counted and the volume of the titrant you entered is 5 mL.

16. Click or touch “OK” to close the “Calibrate Sensor” window. Click or touch in the Graph display to close the “Configure sensors and measurements” menu.

About the Calibration

Calibration information is stored in the Wireless Drop Counter Sensor and can be used by both PASCO Capstone and SPARKvue. The information can be changed as needed. Note that if you use a different liquid as the titrant, or if you change the drop rate or drop size by adjusting the stopcock valves on the Drop Dispenser, you will need to re-calibrate.

Calibrate Sensor: Enter Values

Calibration Point 1

Calibration Point 2

Standard Value: 5 mL

Sensor Value: 10.000 drops

Set Calibration

New Calibration ← Touch or Click to see the results

Slope: 2.0000 drops/mL

The “Slope:” is 2.0000 because the sensor counted 10 drops and you entered 5.0 mL as the volume

Offset: 0.0000 drops

Cancel OK

Acid-Base Titration (Calibration Method)

1. Setup the equipment and consumables as shown.
 2. Start the data acquisition software.
 3. In the software, “pair” (connect) the Wireless Drop Counter and a Wireless pH Sensor
 4. Use the software to create a graph display of pH (vertical axis) vs. Fluid Volume (horizontal axis).
 5. Start the magnetic stirrer. Check that the micro stir bar is able to rotate.
 6. In the software, touch, or click “Start” or “Record” to begin recording data.
 7. Adjust the stopcock valves on the Drop Dispenser so the titrant drops fall at about 1 drop per second.
 8. Observe the data on the pH versus Fluid Volume graph. After the equivalence point is reached, continue collecting data until the pH curve flattens.
 9. Close the stopcock valve and stop data recording.
- In the software, touch or click the Start (or Record) button to begin collecting data.

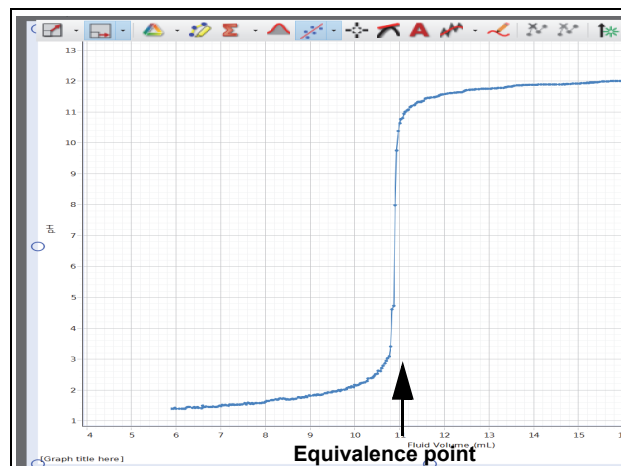

Other Titrations

Titrations with different solutions can be performed using the same equipment and procedure. Other probes (such as conductivity or ORP) can be used in place of the pH probe.

Theory of Operation

The Wireless Drop Counter uses an infrared light source and a photodetector. Lenses spread the light into a “sheet” and refocus it onto the photodetector. When a drop of fluid passes through the Wireless Drop Counter, it partially blocks this sheet of light, and the photodetector registers a momentary decrease in light intensity.

The Wireless Drop Counter uses infrared light and ignores visible light. On power up, it automatically adjusts the light level for the best sensitivity. Use the Wireless Drop Counter away from direct sunlight or other sources of infrared that may interfere with it.

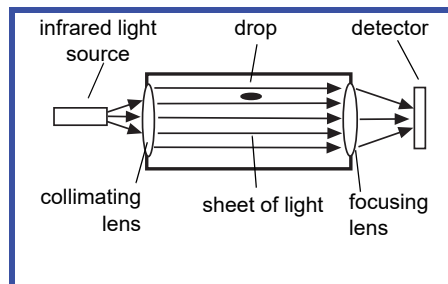

Troubleshooting the Sensor

Problem	Cause	Solution
Indicator light flashes twice for a single drop. Wireless Drop Counter registers more drops than actually dispensed.	Fluid is splashing back into the drop window.	Adjust the position of the beaker, Wireless Drop Counter, or Drop Dispenser to eliminate splash back
Indicator LED remains on constantly. Wireless Drop Counter does not register drops.	Lenses in drop window are dirty or wet.	Clean lenses in the drop window with water or a glass cleaner and dry with a cotton swab or tissue.

- If the sensor loses Bluetooth connection and will not reconnect, try cycling the ON button. Press and briefly **hold** the button until the status LEDs blink in sequence, and then release the button. Start the sensor in the usual way.
- If the sensor stops communicating with the computer software or tablet application, try restarting the software or application. If the problem remains, press and **hold** the ON button on the sensor for 10 seconds and then release. Start the sensor in the usual way.
- On the computing device, turn Bluetooth off and then back on. Retry.
- If the Wireless Drop Counter will not turn on, use the micro USB cable to connect it to a USB port or charger.

See the PASCO web site at www.pasco.com for more information.

Probe Care and Maintenance

The Wireless Drop Counter Sensor is splash resistant but not waterproof. Do not immerse the sensor in liquid. If the inside surfaces of the rectangular drop window need to be cleaned, Use a piece of lens paper or a lint free cloth and water or a glass cleaner.

Tips

- Except for opening and closing the stopcocks, do not touch the syringe of the Drop Dispenser during the titration; otherwise, the drop size may change significantly.
- The drop rate must remain approximately constant (for example, about 2 drops per second) in order for the drop size to remain constant.
- Drop size depends on the exact position of the stopcock valves. Therefore, the average drop size will be different for every titration. For each different titration, re-calibrate the sensor because the new titrant may have different sized drops if it has a different density.

Specifications

Item	Value
Maximum Drop Count Rate:	40 drops per second
Minimum Object Detection Size	0.64 mm
Drop Window	18 mm by 13 mm
Enclosure	Polypropylene, water resistant, chemically resistant to mild acids and bases
Detector Type	Infrared photodetector with collimating lens
Default Sample Rate	5 Hz
Maximum Sample Rate	10 Hz
Logging Mode	No

Technical Support

For assistance with any PASCO product, contact PASCO at:

Address: PASCO scientific
10101 Foothills Blvd.
Roseville, CA 95747-7100

Web: www.pasco.com

Phone: +1 916-462-8384 (worldwide)
877-373-0300 (U.S.)

Email: support@pasco.com

Check the PASCO website for the latest version of the instruction manual.

www.pasco.com/manuals

Limited Warranty For a description of the product warranty, see the PASCO catalog. **Copyright** The PASCO scientific *Instruction Manual* is copyrighted with all rights reserved. Permission is granted to non-profit educational institutions for reproduction of any part of this manual, providing the reproductions are used only in their laboratories and classrooms, and are not sold for profit. Reproduction under any other circumstances, without the written consent of PASCO scientific, is prohibited. Rev: 01/19. **Trademarks** PASCO, PASCO Capstone, and SPARKvue are trademarks or registered trademarks of PASCO scientific, in the United States and/or in other countries. For more information visit

www.pasco.com/legal.

Product End of Life Disposal Instructions:

This electronic product is subject to disposal and recycling regulations that vary by country and region. It is your responsibility to recycle your electronic equipment per your local environmental laws and regulations to ensure that it will be recycled in a manner that protects human health and the environment. To find out where you can drop off your waste equipment for recycling, please contact your local waste recycle/disposal service, or the place where you purchased the product.

The European Union WEEE (Waste Electronic and Electrical Equipment) symbol (shown to the right and on the product or its packaging) indicates that this product **must not** be disposed of in a standard waste container.



Battery Disposal Instructions:

Batteries contain chemicals that, if released, may affect the environment and human health. Batteries should be collected separately for recycling, and recycled at a local hazardous material disposal location adhering to your country and local government regulations. To find out where you can drop off your waste battery for recycling, please contact your local waste disposal service, or the product representative.

The Lithium Polymer (Li-Poly) rechargeable battery used in this product is marked with the International symbols to indicate the need for the separate collection and recycling of batteries.



Li-Poly



Appendix A: Bluetooth Compatibility

Check the PASCO website at www.pasco.com/compatibility.

Platform	Bluetooth SMART Compatibility
iOS	iPad 3 and later iPhone 4S and later iPod touch 5 and later
SPARK LX / LXi	All models
Android	Android 4.4 and later
Chrome OS	Chromebooks with Bluetooth 4.0
Mac OS X	Models introduced July 2011 or later ¹
Windows	Windows 7 and later (requires PS-3500 Adapter*)
Windows 10 Creator	All models

*The PS-3500 USB Bluetooth 4.0 Adapter, when connected to a USB port, allows up to three Bluetooth SMART devices, such as this PASCO wireless device, to connect to some Windows computers, some Chromebooks, and older Macintosh computers.

Note: The PS-3500 USB Bluetooth 4.0 Adapter is the only adapter we can currently recommend. Many other Bluetooth 4.0 adapters are available but this adapter has a specific design that enables in-app pairing of Bluetooth SMART sensors.

¹To check the Mac computer's Bluetooth compatibility, do the following:

- Click the  (Apple) Menu.
- Select *About This Mac*
- Click the *System Report...* button.
- Select *Bluetooth* from the sidebar on the left, underneath *Hardware*.
- Scan down the list of information until you find "LMP Version".
- If your Mac is equipped with Bluetooth SMART, the LMP Version will show **0x6**. (Anything lower than **0x6** means an older version of Bluetooth. Your device will need the PS-3500 USB Bluetooth 4.0 Adapter.)

¹The Mac Mini and MacBook Air were updated with Bluetooth SMART support in 2011. The MacBook Pro was updated in 2012. The Mac Pro that debuted in December 2013 has Bluetooth SMART support.

Exception: Before you upgrade to El Capitan (Mac OS X 10.11.x), if you have a Macintosh with LMP version "0x4" that requires the PS-3500 USB Bluetooth 4.0 Adapter, please contact PASCO Technical Support for further instructions.



