

# EcoChamber

ME-6667

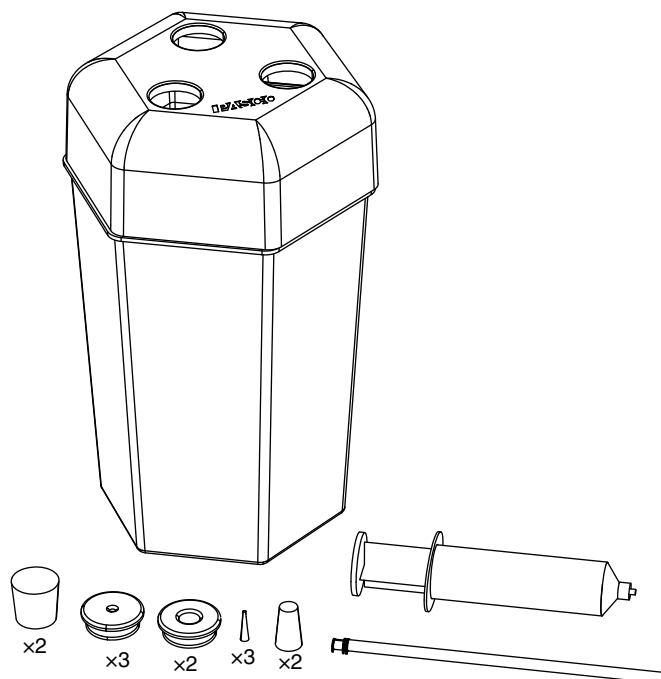

## Included Equipment

- EcoChamber with lid
- 12 assorted stoppers for closing unused holes
- Syringe and plastic tubing with connector for sampling water, replenishing water, and injecting pollutants

## Required Items\*

PASCO Interface

PASCO Data Collection Software

\*See the PASCO web site at [www.pasco.com](http://www.pasco.com) or the PASCO catalog for information about interfaces and software.

## Recommended PASPORT Sensors and Equipment

- Water Quality Sensor (PS-2169)
- Oxygen Gas Sensor (PS-2126)
- Carbon Dioxide Sensor (PS-2110)
- Temperature Sensor (PS-2125)
- Weather Sensor (PS-2154)
- Turbidity Sensor (PS-2122)
- Ethanol Sensor (PS-2194)
- Water Quality Colorimeter (PS-2179)
- ezSample Water Quality Testing Kits:
  - Iron (EZ-2331)
  - Nitrate (EZ-2333)
  - Ammonia (EZ-2334)
  - Phosphate (EZ-2337)
  - Chlorine (EZ-2339)

## Recommended ScienceWorkshop Sensors<sup>1</sup>

- Oxygen Gas Sensor (CI-6562)
- CO<sub>2</sub> Sensor (CI-6561)
- Temperature Sensor (CI-6526)
- Colorimeter (CI-6747)

<sup>1</sup>NOTE: ScienceWorkshop Sensors require the PS-2159 Analog Adapter in order to connect to a PASPORT interface.

## Introduction

The PASCO ME-6667 EcoChamber is designed to help students model and understand the complex interactions within ecosystems. The clear acrylic EcoChamber is designed to accommodate PASCO sensors, making qualitative and quantitative measurements as easy as visual observation.

The unique design of the EcoChamber allows the system to remain closed, which allows for measurements to have a minimal impact on the system. Environmental science probes can be used to actively measure variables in the ecosystem model. A syringe and tubing are included to extract water for chemical testing,

replenish water without opening the system, and inject pollutants for chamber manipulation.

## Equipment Set-up

1. Fill the EcoChamber according to the instructions in the lab you are performing.
2. Select the sensors and interface that you intend to use for the experiment.
3. Place the lid onto the EcoChamber.
4. Insert large stoppers with holes into the holes in the lid.
5. Insert probes into the holes in the stoppers.
6. Use solid stoppers to fill any unused holes.
7. Connect the sensors to a PASPORT or other interface.

## Sensor Calibration







Calibrate sensors prior to using them in an experiment. Refer to the documentation provided with each sensor for calibration instructions.

*Note: In some cases, sensors do not require calibration. If, for example, you wish to measure only relative dissolved oxygen changes, the sensor does not to be calibrated.*







## Xplorer GLX Set-up

*Note: The interface set-up and data collection instructions apply to the Xplorer GLX datalogger. Other data collection systems can also be used.*

EcoChamber experiments are typically long-term experiments. If data is collected at the default rate, the volume of information may fill the memory of the GLX before the end of the experiment. To prevent the Xplorer GLX from ending the experiment early, change the sample rate of every sensor.

1. Press  +  to access the Sensors screen. The sensors currently connected to the Xplorer GLX will show across the top of the screen. The Sample Rate Unit will be highlighted for the sensor in port 1.
2. Press  to see the available sample rate units for that sensor. Highlight “minutes” using the arrow keys and press .
3. Use the arrow keys to highlight Sample Rate and press . Change the sample rate to 1, 2, or 5 minutes between samples.
4. Use the arrow keys to highlight the sensor in port 2. Press  to select that sensor, and repeat steps 2 and 3 to change the sample rate. Do this for the remaining sensors.

## Data Collection

1. Ensure that the GLX is in Continuous data collection mode.
  - a. Press  +  to access the Sensors screen.
  - b. Press  to access the Mode menu. If necessary, use the arrow keys to select Continuous and press .
2. With the sensors in place, press  to begin recording data.
3. Allow the experiment to run for the specified time. Do not bump or jar the EcoChamber, as this may cause the sensors to record erratically.
4. Press  to stop collecting data.

## Data Analysis

Graphs showing two variables changing over time are most valuable in the EcoChamber experiments because they show the relationship between related quantities, such as oxygen and carbon dioxide concentrations, and how these relationships changes over time.

## Example Activities

**Aerobic Respiration and Fermentation in Yeast** Place the EcoChamber on a magnetic stirrer. Put a stir bar in the bottom of the chamber. Pour 100 ml of 20% yeast solution and 500 ml of 0.5 M sucrose solution into the chamber. Place an oxygen gas sensor, a carbon dioxide gas sensor and an ethanol gas sensor into holes in the lid. Put the lid on the chamber and press to tightly seal the chamber. Make sure that all other holes in the EcoChamber are filled with stoppers. Turn on the stirrer to a medium setting and begin collecting data. Observe oxygen, carbon dioxide, and ethanol levels for 60 minutes.

**Measuring Photosynthesis** Place a small potted plant in the bottom of the EcoChamber. Put an oxygen gas sensor and a carbon dioxide gas sensor into the holes in the lid. Place the lid on the chamber and press firmly to seal. Make sure that all other holes in the lid are filled with stoppers. Begin collecting data. Observe photosynthesis by measuring oxygen production and carbon dioxide consumption for 30 to 60 minutes.

### Effects of Temperature on Photosynthetic Activity

Repeat the experiment above, but place a floodlight in front of the chamber. Turn the light on for 20 minutes. After 20 minutes, begin collecting data (with the light off). Continue collecting for 20 minutes with the light off. After 20 minutes, put a dark cloth over the tank and collect data for another 20 minutes.

## Technical Support

For assistance with any PASCO product, contact PASCO at:

Address: PASCO scientific  
10101 Foothills Blvd.  
Roseville, CA 95747-7100

Phone: 916-786-8384 (worldwide)  
877-373-0300 (U.S.)

Web: [www.pasco.com](http://www.pasco.com)

Email: [support@pasco.com](mailto:support@pasco.com)

For more information about the EcoChamber and the latest revision of this Instruction Sheet, visit the PASCO web site at [www.pasco.com](http://www.pasco.com) and enter ME-6667 in the Search window.

**Limited Warranty** For a description of the product warranty, see the PASCO catalog. **Copyright** The PASCO scientific 012-10652B *EcoChamber Instruction Sheet* is copyrighted with all rights reserved. Permission is granted to non-profit educational institutions for reproduction of any part of this manual, providing the reproductions are used only in their laboratories and classrooms, and are not sold for profit. Reproduction under any other circumstances, without the written consent of PASCO scientific, is prohibited. **Trademarks** PASCO, PASCO scientific, DataStudio, ezSample, PASPORT, ScienceWorkshop, Xplorer, and Xplorer GLX are trademarks or registered trademarks of PASCO scientific, in the United States and/or in other countries. All other brands, products, or service names are or may be trademarks or service marks of, and are used to identify, products or services of, their respective owners. For more information visit [www.pasco.com/legal](http://www.pasco.com/legal).