



Discover Rotation Platform

Model No. ME-6834





Table of Contents

Equipment List	1
Introduction	2
Basic Operating Procedure	2
Rotating on the Stool	2
Sitting or Laying on the Platform	3
Accelerating the Platform with a Rope	3
Attaching a Photogate for Motion Measurements	4
Suggested Experiments	5
Moment of Inertia Experiments	5
Torque Experiments	5
Appendix A: Technical Support	6

Discover Rotation Platform

Model No. ME-6834

Equipment List

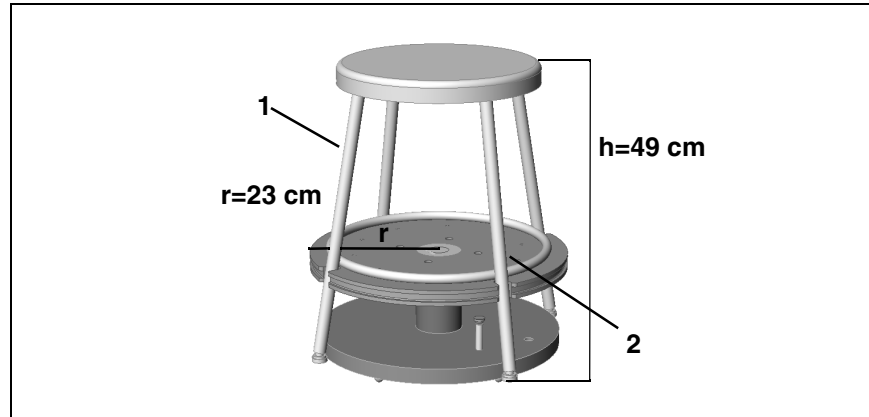

Included Equipment	Replacement Model Number*
1. Stool	699-128
2. Rotational Platform	003-07900
3. Discover Rotation Platform Manual	012-07923

*Use Replacement Model Numbers to expedite replacement orders.

Additional Equipment Suggested (for experiments)	Replacement Model Number*
PASCO interface (500, 750 (SCSI or USB), USB link, Xplorer, PowerLink or Smart Timer)	CI-6400 or CI-6450 or CI-7650 or PS-2100 or PS-2000 or PS-2001 or ME-8930
Accessory Photogate	ME-9204B
Photogate Head	ME-9498A
Smart Timer	ME-8930
Photogate Port (for use with a USB link, PowerLink, or Xplorer)	PS-2123A
Force Sensor (<i>ScienceWorkshop</i> [®] or <i>PASPORT</i> [™])	CI-6746 or PS-2104
Bicycle Wheel Gyroscope	ME-6833

Introduction

PASCO's Discover Rotation Platform is designed to help students learn the basics of rotational motion and inertia by experiencing motion themselves. The platform features a stool that can be placed on the platform for rotational studies with the student sitting. In addition, the stool can be removed, and students can sit or lay directly on the platform.

The Accessory Photogate (ME-9420B) or Photogate Head (ME-9498A) can be used to instrument the Discover Rotation Platform for measurements of position, velocity, and acceleration. These measurements can be made in both linear and rotational units. The photogate must be connected to a Smart Timer (ME-9830), ScienceWorkshop 500/750 interface, or the PASPORT Photogate Port (PS-2123) to obtain the above kinematics measurements.

Basic Operating Procedure

Rotating on the Stool

By placing the included stool over the platform, students can investigate the basics of rotational motion.

1. Slide the stool over the platform.
2. Fit each leg into a groove on the upper platform.

Note: The bottom of each leg has a 19 mm clearance from the ground, so remove objects that might interfere with the operation of the stool. *For optimal performance, keep the stool on a hard floor. The stool may not rotate on carpeting.*

3. To rotate, place feet on the foot rungs or extend them out from the stool (See Figure 1).

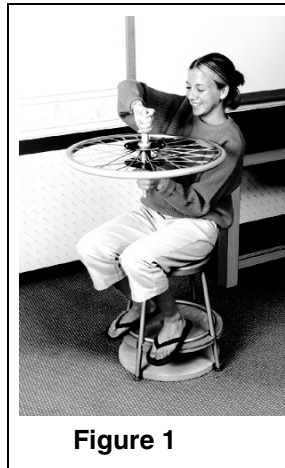

Figure 1



Warning: Always remove any objects that might interfere with the rotation of the stool. Placing objects underneath the platform could damage the platform or cause injury.

Sitting or Laying on the Platform

The stool can also be removed so students can sit or lie directly on the platform for rotational studies.

1. Have the student sit or lie directly on the platform (see Figure 2).
2. To study the effects of body position on rotational inertia, have the student tuck their arms and legs in or extend them out while rotating.

Note: For optimal rotation, keep the stool on a hard floor. The stool may not rotate on carpeting.



Figure 2



Warning: Without the stool, students have nothing to hold onto, so it is important that students on the platform wear clothing that is not too slick. If necessary, place a non-skid pad on the upper platform to add friction between the rider and the platform.

Accelerating the Platform with a Rope

The platform can be accelerated with the push of a hand or the use of a rope. The rope has the advantage of providing a force at a known distance from the axis of rotation (torque). This is very useful when using the $\tau = I\alpha$ expression to investigate rotational motion.

1. Slip one end of the rope between the foot rung and the upper platform, then wind the desired length of rope in the groove (see Figures 3a and 3b below).

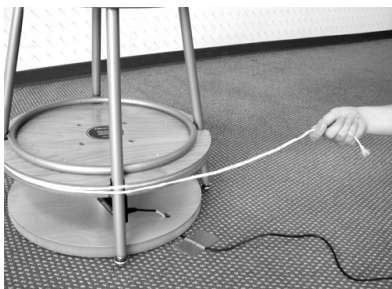

Figure 3a



Figure 3b

2. Be sure to pull the rope free when finished applying the torque to the platform.

Note: It is best to use rope that has minimal stretch. A great way to measure the force exerted on the platform is to tie the free end of the rope to a force sensor and pull it to apply the torque (see Figure 4 on page 4). In all cases, be certain to pull tangent to the platform.



Figure 4

Attaching the Photogate for Motion Measurements

PASCO's Accessory Photogate (ME-9204B) or Photogate Head (ME-9498A) can be attached to the bottom platform and used with the built-in spokes to create a smart pulley.

1. Use the included thumbscrew to attach the Photogate Head to the bracket on the bottom platform. (See Figures 5a and 5b).

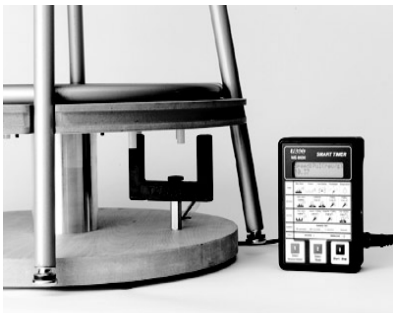

Figure 5a

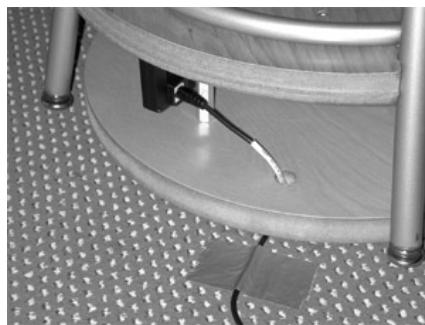

Figure 5b



Warning: If using the stool, be sure to tape the photogate cord to the floor to avoid interference with the stool.

2. Connect the photogate to an interface, such as a 500 or 750 *ScienceWorkshop* interface.

OR

Connect the PASPORT Photogate Port (PS-2123) to a USB Link or Xplorer.

3. Students can now measure position, velocity, and acceleration of the platform and its rider from both linear and rotational frames of reference.

Suggested Experiments

Moment of Inertia Experiments

Students can both qualitatively and quantitatively investigate the moment of inertia with the Discover Rotation Platform.

1. Ask a student to sit on the stool of the Discover Rotation Platform with 5 kg masses in each arm (see Figure 6).
2. Have the student sitting on the stool (the rider) extend his/her arms outward.
3. Have another student (or lab partner) rotate the rider.
4. After gaining speed, ask the rider to pull the masses into his/her chest. Qualitatively, the rider and observers will notice the increase as the masses are pulled toward the center axis of rotation.
5. Use a photogate to provide quantitative measurements of position, velocity, and acceleration.

Using the expression $\tau = I\alpha$, students can relate the angular acceleration that results when the masses are moved inward to a decrease in the moment of inertia of the system.

Torque Experiments

By applying different torques to the platform and using the photogate to measure the angular acceleration, students can produce a graph to help them discover the moment of inertia for the system.

1. Attach the Photogate Head to the bottom platform.

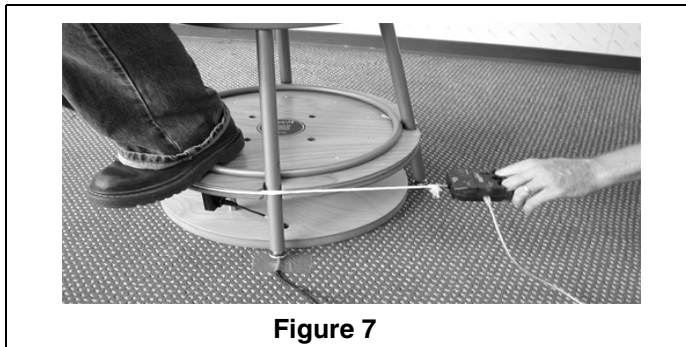

Figure 7

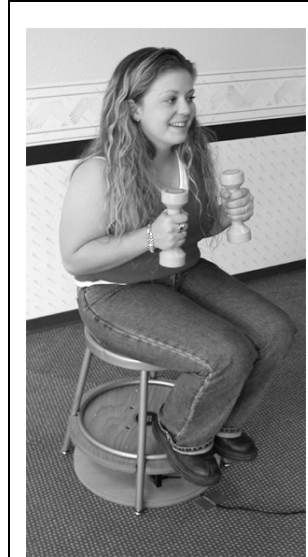

Figure 6



Warning: Ask students to tightly grip the weights with their hands and fingers. To avoid injuries, always enforce appropriate safety precautions in the classroom.



Note: For optimal rotation, keep the stool on a hard floor. The stool may not rotate on carpeting.

Torque Experiments (continued)

2. Wrap a rope or string around the groove of the upper platform (see Figure 7).
3. Attach a Force Sensor to the rope.
4. Ask one student to sit on the stool.
5. Ask another student to pull the rope to accelerate the rider. Be certain to pull the rope tangent to the platform.
6. Repeat step 5 two more times, increasing the amount of force (torque) in each case. A graph with torque on the vertical axis and angular acceleration on the horizontal axis will produce a slope equal to the moment of inertia for the system.
7. The experiment could then be repeated with the mass of the system distributed in a different fashion. For instance, the student could be tucked in while rotating on the platform in the first experiment and have arms extended in the second experiment.

Technical Support

For assistance with the ME-6834 Discover Rotation Platform or any other PASCO products, contact PASCO as follows:

Address: PASCO scientific

10101 Foothills Blvd.

Roseville, CA 95747-7100

Phone: (916) 786-3800

FAX: (916) 786-3292

Web: www.pasco.com

Email: techsupp@pasco.com